

# WARNING

**You are dealing with very high energy levels when using this system, which may result in personal injury or fire when handled improperly. Take appropriate safety measures and use this system with great caution. Never leave it unattended while being powered.**

**This product contains small parts, keep out of reach of children!**

**This system produces significant magnet fields, do not use it when you have a cardiac pacemaker!**

## DISCLAIMER

This product is provided as is without any guarantees or warranty, except where obliged by national law. In association with the product, [www.keenlab.de](http://www.keenlab.de) makes no warranties of any kind, either express or implied, including but not limited to warranties of merchantability, fitness for a particular purpose, of title, or of noninfringement of third party rights. Use of the product by a user is at the user's risk.

In no event shall [www.keenlab.de](http://www.keenlab.de) be liable for any direct, indirect, punitive, incidental, special, or consequential damages whatsoever arising out of or connected with the use or misuse of any product purchased herein. You agree and acknowledge that any product purchased should be used at your own risk and you should assess the risks before purchasing any product or using any product. You agree that in the event that [www.keenlab.de](http://www.keenlab.de) is deemed liable for any harm caused, the amount which it shall be liable to you shall be limited to the cost of the product.

NO REPRESENTATIONS OR WARRANTIES, EITHER EXPRESS OR IMPLIED, OF MERCHANTABILITY, FITNESS FOR A SPECIFIC PURPOSE, THE PRODUCTS TO WHICH THE INFORMATION MENTIONS MAY BE USED WITHOUT INFRINGING THE INTELLECTUAL PROPERTY RIGHTS OF OTHERS, OR OF ANY OTHER NATURE ARE MADE WITH RESPECT TO INFORMATION OR THE PRODUCT TO WHICH INFORMATION MENTIONS. IN NO CASE SHALL THE INFORMATION BE CONSIDERED A PART OF OUR TERMS AND CONDITIONS OF SALE.

# KWELD OPERATING MANUAL

The *kWeld* "Next level" battery spot welder is available in kit form:

<https://www.keenlab.de/index.php/product-category/kspot-welder-kit/>

This manual is available online in PDF format at

<https://www.keenlab.de/wp-content/uploads/2018/07/kWeld-operation-manual-r3.0.pdf>

If you have not yet assembled the kit, please download the assembly manual at

<https://www.keenlab.de/wp-content/uploads/2018/07/kWeld-assembly-manual-r5.0.pdf>

and follow the instructions given there.

## THE STORY

If you want to make your own battery packs from Lilon round cells, then you have to solve the problem of connecting the individual cells. Soldering wires to them is not an option, because the required prolonged heat at the battery tabs tends to damage the cell's inner structure.

I faced exactly this problem, and learned that the most common method to interconnect the cells is to weld nickel or nickel-plated steel strips across them using resistance spot welders.

The working principle of these is to push electrical current through metal strip and battery tab. As the metals have an electrical resistance, this current causes the material to melt together. The molten metal should only occupy a small area to prevent damage to the battery. This is accomplished by using a high current, allowing for very short pulses.

As this is a challenging task to achieve, professional welders start at several 1000\$. There are cheaper models from a Chinese company, but I decided against this option... As I am an electronics engineer with quite some experience in power electronics, I decided to develop my own welder. It should be affordable for DIY'ers, more powerful and robust than comparable designs, and simple to use.

And I didn't like the fact that seemingly all spot welders would use a preset pulse length to set the weld intensity. The flowing current typically cannot be regulated; instead it varies with the electrical resistance of the weld spot itself. And that depends on quite a few factors like contamination, corrosion, and the mechanical force at which the metals are pushed together. The result is a variation in the amount of energy (=heat) that goes into the weld, leading to inconsistent results. To mitigate this effect, modern welders use two or more pulses, in order to soften the metals and burn away any contamination.

But there is a much more straight forward way to obtain consistent welds: If the amount of energy that is dumped into the weld spot is kept constant, then the same amount of metal is molten each time. This is what *kWeld* does. There is no need to experiment with time intervals, or the number of cleaning pulses. You just dial in the desired energy amount, and start working. The unit automatically adjusts the pulse duration to achieve the same result with each and every weld.

This picture shows the result of welding 0.15mm nickel strips to 18650 cells (source: eevblog forum, user "romantao"):

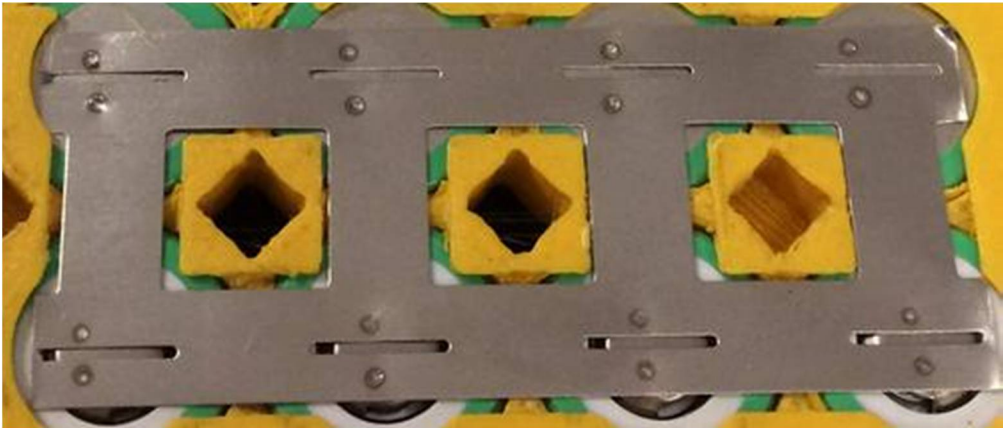

With the right power source, the *kWeld* unit is capable to weld pure nickel strips of up to 0.3mm thickness. But it is also agile enough to weld thin copper wires at low energies. The following picture shows a thin copper strand welded to a 2mm steel rod:

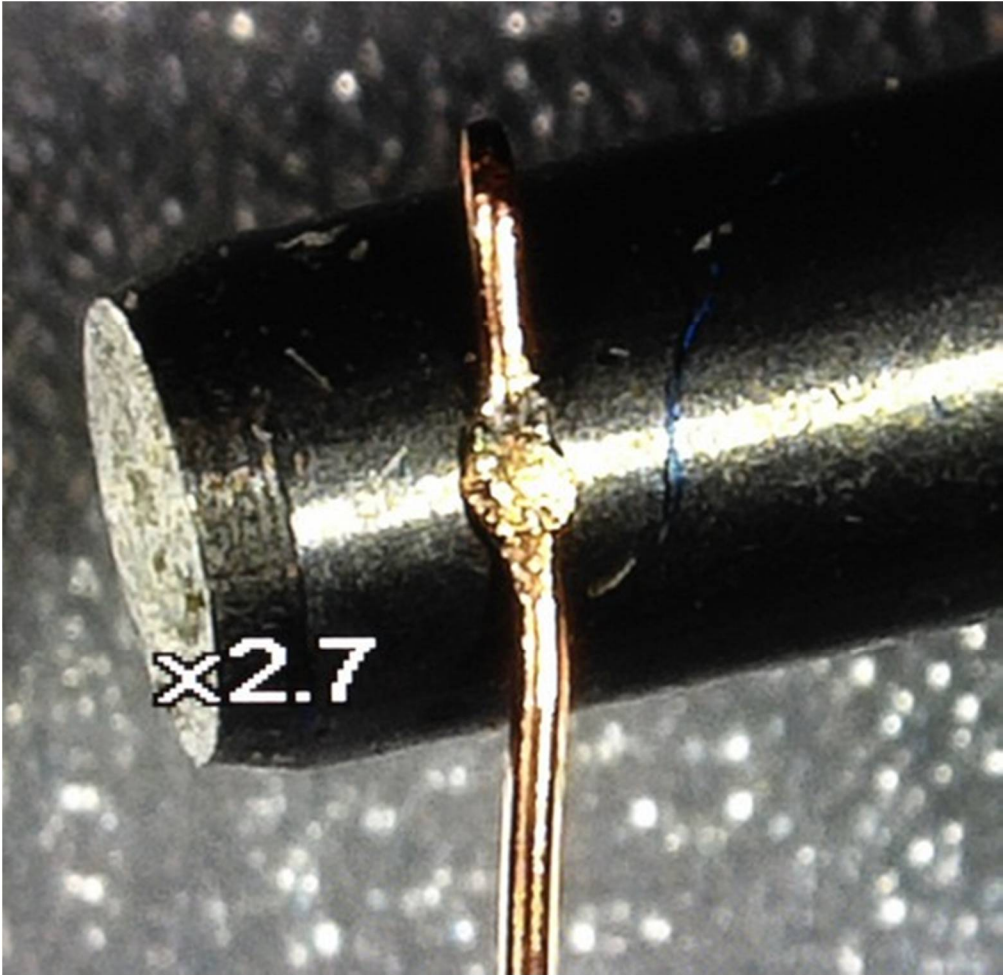

## OVERVIEW

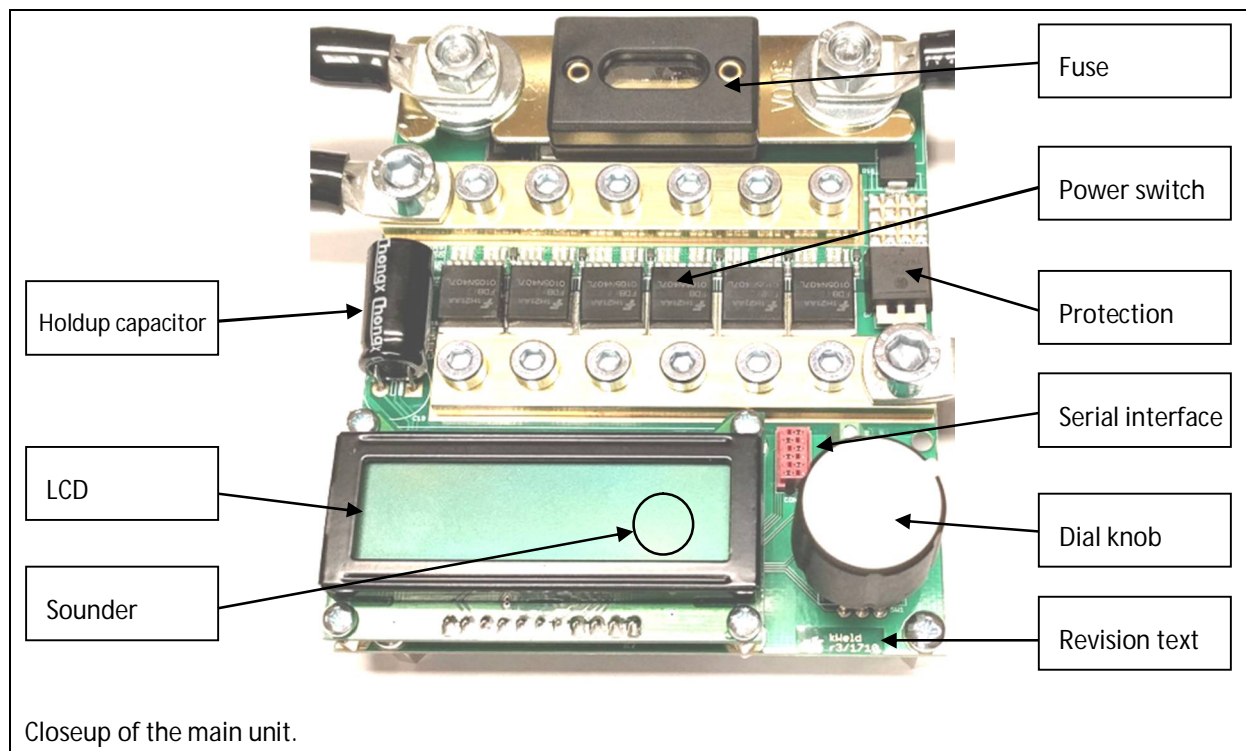
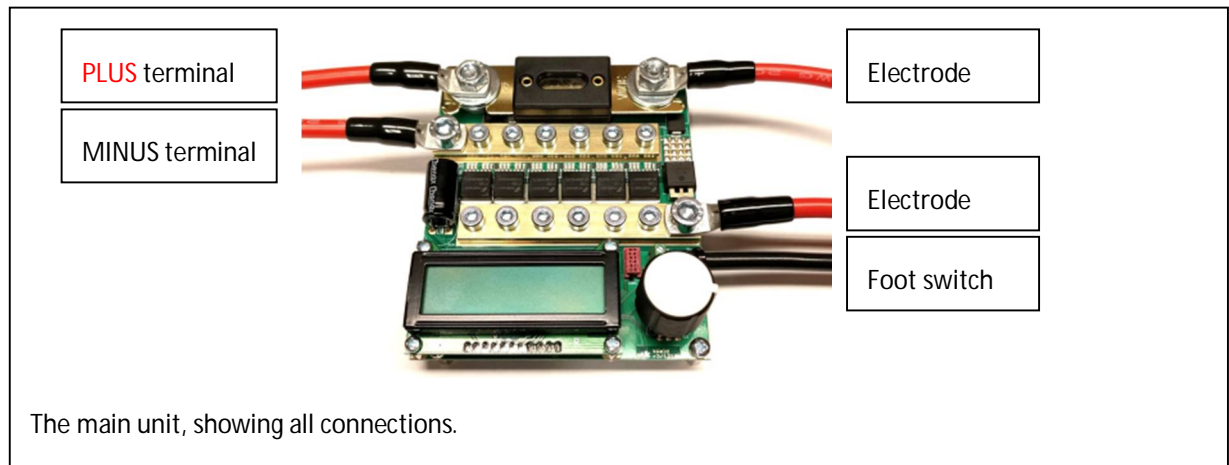

## SPECIFICATIONS

### Hardware:

- Input voltage for welding: 4V - 30V, enabling the use of ultracapacitors
- Extremely rugged MOSFET-based power switch and mechanical current bus design
- Fused overvoltage protection of internal power supply
- Maximum switch current: 2000A
- Maximum inductive kickback energy handling capability: 2J
- Power switch internal resistance: 170 $\mu$ Ohm typical
- Pulse duration hardware watchdog: 250ms
- Undervoltage lockout and temperature monitoring for power switch transistors
- Measurement of input voltage ( $\pm 2\%$ ), output voltage ( $\pm 2\%$ ), switch current ( $\pm 30\%$ ), and logic supply voltage
- Logic supplied directly from main input - no need for a separate auxiliary power supply
- Screw terminal for external trigger switch
- Logic supply holdup capacitor during pulse firing
- Simple user interface via an LCD, a dial/encoder, and a beeper
- 3.3V logic level serial interface (adapter required – available in shop)

### Software:

- Central weld control algorithm uses a Joule metering approach instead of a simple timer, eliminating the need for two-pulse firing and providing more consistent welds - the amount of energy that is deposited into the weld spot is always kept constant
- Manual mode, triggered from external switch
- Automatic mode: pulse firing after a delay when the system detects that both electrodes are kept in steady contact with the weld material
- Acoustic feedback of weld process
- Numeric feedback from an executed weld, assisting the user to achieve best results by displaying measurement results from welding process
- Simple and intuitive user interface - just adjust the desired weld energy up to 500 Joules with the dial knob
- Configuration menus accessible via dial's push button
- Calibration procedure to cancel out electrode lead losses
- Ability to detect a failed weld, including acoustic feedback
- Overcurrent monitoring aborts pulse when triggered, protecting the power switch
- Battery monitoring with adjustable warning voltage
- Fuse fitness monitoring
- Firmware update interface

## SELECTING A SUITABLE POWER SUPPLY

The power supply is not part of the *kWeld* kit and needs to be supplied by the user. As it has to be able to deliver a very high current during short time periods, the available options are limited. The following table discusses some of them.

Lithium polymer battery	Mainly used in RC models, this is one of the most advanced types of rechargeable battery in terms of power density. Modern large capacity models deliver short-circuit currents of thousands of amperes. However, their biggest drawback is that they react sensitively to any kind of abuse like the case in this application. Many standard types can deliver the required current, but they wear quickly and will show this by swelling. As these RC model batteries typically do not have the same protection mechanisms like they are implemented in e.g. smart phones, they are potentially dangerous. If they fail internally, they can spontaneously self-ignite. It is therefore strongly advised to permanently supervise them during use and also while charging them, and to store them in a fire safe container when not using them.
Lead-acid starting battery	Their internal construction is optimized for high current output, and they are very robust when being abused. Their main drawback is their weight and size.
Supercapacitor	These deliver unparalleled power density and charge/discharge cycle lifetime, but their energy density is only a fraction of that of a rechargeable battery, yet at a higher cost. They require balancing circuitry when wired in series, and their limited capacity demands a capable power supply that can quickly restore the charge that is taken from them by a rapid succession of weld pulses.
Low voltage / high current transformer with bridge rectifier	This setup delivers a discontinuous voltage and current. As the <i>kWeld</i> system measures output power with a very high update rate of 100kHz, it should still be possible to produce consistent welds. However, this is yet to be confirmed.

The product page contains a list of power supplies that have been found to be suitable for use with the *kWeld* system: <https://www.keenlab.de/index.php/portfolio-item/kweld/>

For all types of batteries, use appropriate undervoltage supervision when using them. For this purpose, the *kWeld* system provides an adjustable battery voltage warning level that has to be configured before use.



## POWER SUPPLY REQUIREMENTS

The *kWeld* system is basically a switch that short-circuits a strong power supply. The resulting current is only limited by the summed resistances in the current path. The following picture illustrates this:

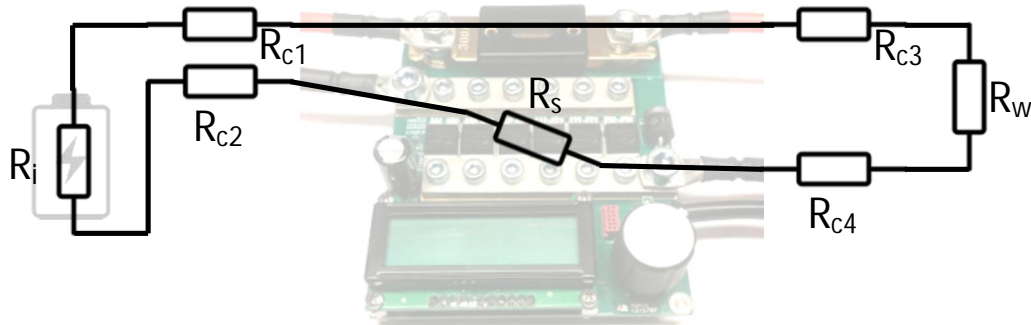

The individual resistors have the following meaning:

$R_i$	The internal resistance of the power supply that you are using.
$R_{c1} + R_{c2} + R_{c3} + R_{c4}$	The summed resistance of all pieces of wire, all contact resistances, and the electrode system up to their tips. The regular <i>kWeld</i> cable assembly and electrode system contributes approximately 2.2 milliOhms to this number. You need to add the resistance of all wires that run between your power supply and the input connectors.
$R_s$	The combined resistance of the <i>kWeld</i> 's circuit board, including the power switch, the fuse, and the bus bars: another 1.1 milliOhms.
$R_w$	The resistance of the weld spot itself. This will of course vary, but the purpose of this discussion is to find the maximum current hence we can set this to zero.

Let's assume first that your power supply has zero internal resistance and generates 12V. According to Ohm's law, the current then calculates to

$$I = \frac{U}{R} = \frac{U}{R_i + R_c + R_s + R_w} = \frac{12V}{0\Omega + 2.2m\Omega + 1.1m\Omega + 0\Omega} = 3636A$$

This would clearly trigger the system's overcurrent protection, which trips at 2000A.

It is now obvious: the only way to limit the current is to control the overall resistance. The recommended current level is 1500A, which ensures enough strength to weld thicker materials, and at the same way provides a reasonable safety margin towards the overcurrent threshold. We can now rearrange the above formula to calculate the required *minimum* internal resistance of the power supply for a given output voltage (in this example again 12V):

$$R_i \geq \frac{U}{I} - R_c - R_s - R_w \geq \frac{12V}{1500A} - 2.2m\Omega - 1.1m\Omega - 0\Omega \geq 4.7m\Omega$$

If the internal resistance of the chosen power supply is already close to this value, then you are all set. If it is larger than this value, you can either live with a smaller current, or you can increase the voltage if that power supply has this possibility. If, on the other hand, the power supply's internal resistance is less than the calculated minimum value, then you remain to have the following options:

- If your power supply supports it, lower the voltage.
- If that is not possible, then you have to add more resistance to the system. The simplest way to do this is by extending the wires that run between power supply and welder. For example, high-flex AWG8 gauge wire adds approximately 2.2 milli-Ohms of resistance per meter.

## WIRING REQUIREMENTS

The previous section recommends extending the wiring length in certain circumstances. Unfortunately, another physical relationship limits us in just doing that. It is that every electrical conductor has an inductance ( $L$ ), and an inductor that carries a current ( $I$ ) stores magnetic energy ( $E$ ). The stored energy calculates at

$$E = \frac{1}{2} L I^2$$

This means, doubling the current quadruples the stored energy. And as we are dealing with very high currents here, the amount of stored energy quickly becomes significant.

The problem with this energy is that it needs to be removed at the end of each weld pulse. This can only be done by converting it into heat, and this heat has to go somewhere. In the *kWeld* system, the thermal load is shared between the switch transistors, the large freewheeling diode to their right, and the ohmic resistance of electrode system and weld spot. As the first two have their limitations, a certain level of stored inductive energy may not exceeded in order to maintain reliable operation. The *kWeld* system has been extensively evaluated with magnetic energies of up to 2.0 Joules. The above formula can now be used to express the relationship between weld current maximum wiring inductance. But as we are interested in the maximum wiring length instead, we need to add the relationship between that and its inductance as well ( $r$  is the radius of an assumed circular wire loop [which is the conductor length divided by  $2\pi$ ];  $a$  is the conductor radius [1.63mm for AWG8]):

$$L = \mu_0 r \left( \ln\left(\frac{8r}{a}\right) - 1.75 \right) \text{ (Wikipedia)}$$

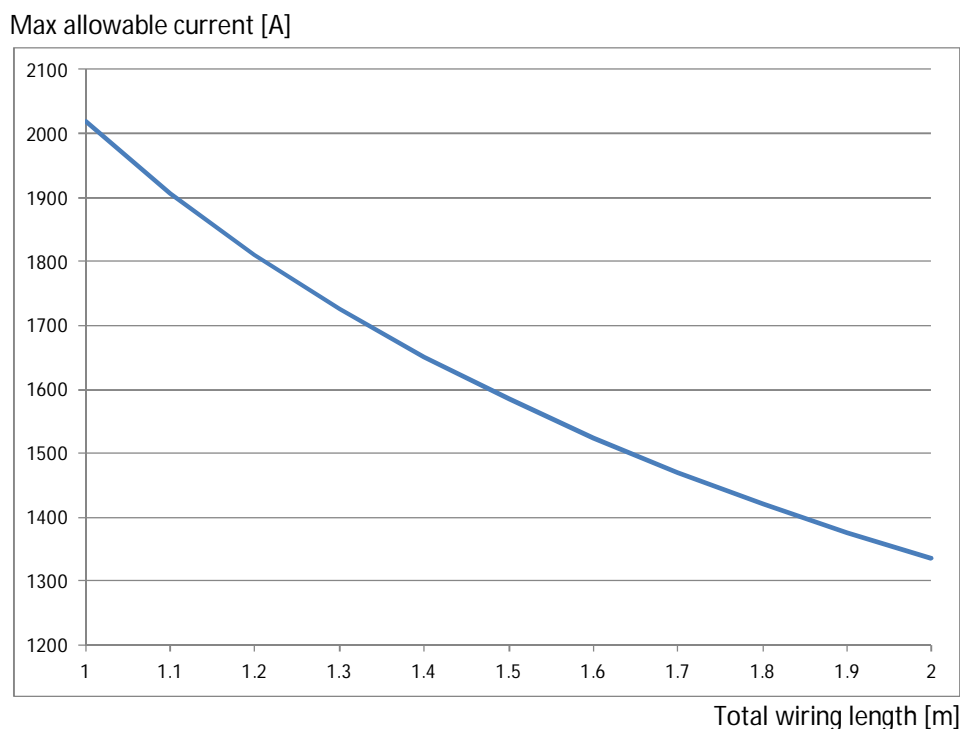

**It is very important to stay within these limits, as exceeding them will likely damage the welder.** For continued protection, the *kWeld* system allows you to dial in your system cabling length, and it calculates an appropriate current limit from that using the above formulas. When not using the standard cabling configuration, it is strongly recommended to adjust this configuration accordingly.



## USING THE WELDER

Before you connect the power supply, you need to decide if you want to use the system in manual or automatic mode. (To learn about the differences, please read sections "Using manual mode" and "Using automatic mode" on pages 11 and 14.)

After the operating mode has been determined once it is connected to the power supply, the system does some basic checks. The first screen shown on the LCD informs you about the installed firmware version:



After a short delay, it measures and displays the input voltage level. This may be useful when using the system with a battery:

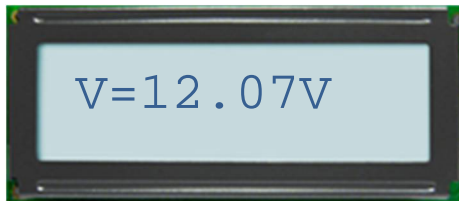

After another short delay, the next screen shows either

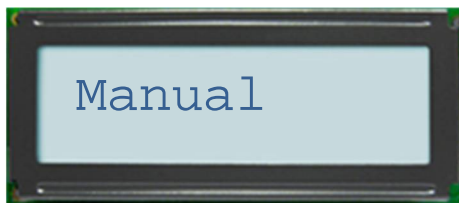

or



depending on your decision as you had powered it up.

If the electrodes are accidentally in contact, then these screens are shown until you have removed this situation:



When these tests have passed, the startup is completed and the system shows its main screen, which is either



Shown when the system has not been calibrated yet. **NOTE:** because the system is shipped in this condition, this is the first screen that you will see. You need to perform a calibration once before the welder can be used. See section "Calibration" on page 15 for details.

or

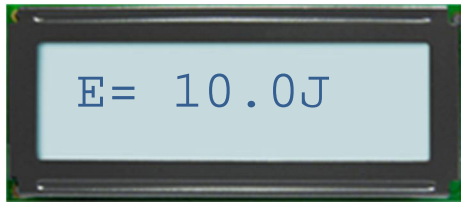

Ready to weld! The screen shows the energy in Joules that will be used for the next weld. Turn the dial knob to adjust this value. Continue reading the next sections to learn how to make welds in manual or automatic mode.

As the system keeps monitoring its condition while waiting for a pulse trigger, it is possible that a few other screens are shown instead, in order to inform you that something is not as it should be:



You have enabled a battery voltage warning level, and the battery voltage is lower than that.



The system has detected a broken fuse. Always seek to find the root cause for the breakage before replacing it with a fresh one.



The power switch temperature is above 70°C and needs to cool down before continuing.

## USING MANUAL MODE

You select manual welding mode during power-up simply by making sure that you do not press down the foot switch when you connect the welder to the power supply. In this mode, you use the foot switch to trigger welding pulses. Alternatively, manual mode can be activated through the menu – see section “Menu” on page 17 for details.

Weld pulse triggering is armed and the welder is ready to go, as soon as this screen is shown:

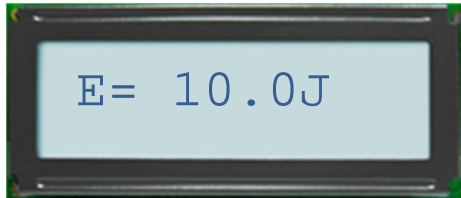

The displayed value is the commanded energy in Joules that shall be dumped into the weld spot with the next trigger. Use the dial knob to adjust this to a level that is suitable for your weld material. The following table gives some values for different materials when used in combination with 18650 type cells. Use them as a starting point only and experiment to find the best adjustment for you, before beginning productive work.

0.1mm pure nickel strip	20J
0.2mm pure nickel strip	50J
0.3mm pure nickel strip	100J

Each weld follows this procedure:

1. Firmly push both electrodes down to the weld material at a slight angle as shown below. Make sure that the electrodes do not touch each other, or you will likely weld *them* together instead.



2. Trigger a pulse by stepping on the foot switch - and keeping your foot down. Don't be frightened, the cables will jump from the high current flowing through them, and the weld spot may emit sparks. You'll see the LCD illumination dim briefly - this is done on purpose to save power during the pulse.
3. Listen to the sound from the welder, as it tells you if the welding process has succeeded or not:
  - a. one short beep signals success
  - b. a higher tone, followed by a lower tone, signals that something went wrong
4. Check the information that is displayed on the LCD (see details below).
5. When finished reading, release your foot from the switch. The results disappear from the LCD and the welder is instantly ready for another go.

As long as you keep your foot on the switch after having triggered the pulse, the system cycles through the following screens to provide you some data that it has collected during the pulse:



*Status information about the executed pulse. See the table below for possible results and their meaning.*

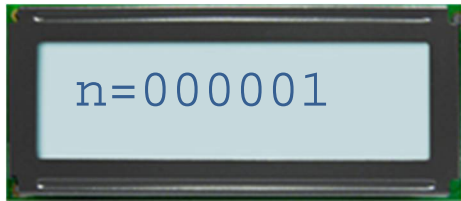

*Counted pulses since power-on.*

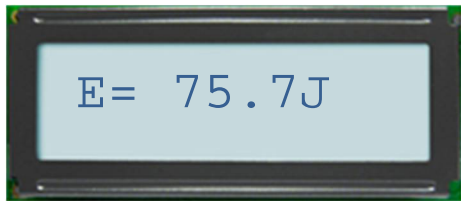

*The amount of energy (in Joules) that was actually delivered by the pulse. If everything went well, then this will be the same as the value that you entered using the dial knob.*

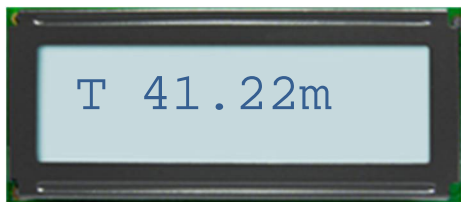

*The pulse duration (in milliseconds) that was necessary to achieve the requested energy level.*

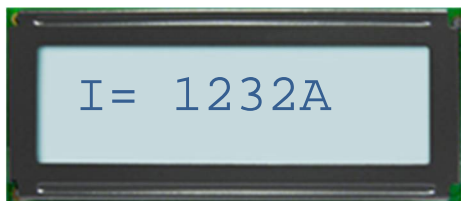

*The average current (Amperes) that was flowing through the weld spot.*

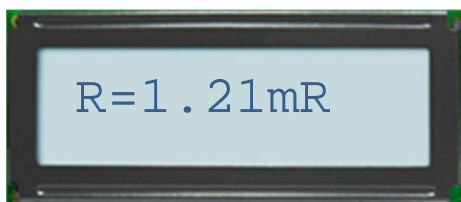

*The calculated average resistance of the weld spot (in milliohms).*

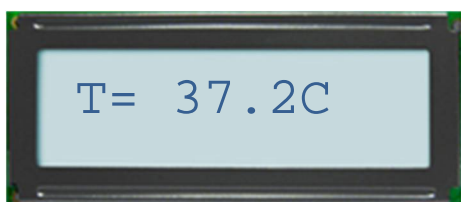

*The power switch temperature (in degrees Celsius).*

The following table explains the possible status texts that may appear on the first screen:

Ok	Everything went well.
Timeout	The maximum pulse duration of 200ms was exceeded. This can be either caused by a bad electrode contact, or the requested energy level cannot be reached in this time period. The reason for the latter can be that the weld spot has a too low or a too high resistance, or the power supply did not deliver enough current.
Batt OV	The input voltage exceeded 40V before or during the pulse. The pulse was aborted to protect the power switch.
Vspot NE	The calculated voltage across the weld spot resulted in a negative value, and the pulse was aborted. This can happen when the stored calibration data does not match the electrical characteristics of the installed probe system. Note that any modification to that, like for example exchanging the electrodes, requires a new calibration.
Vspot OV	The calculated voltage across the weld spot exceeded 40V, and the pulse was aborted. This error should never occur, please perform a new calibration to resolve it. If that doesn't help, please contact me at <a href="https://www.keenlab.de">https://www.keenlab.de</a> .
Overcurr	The weld current exceeded 2000A (or the calculated limit according your cable length entry), and the pulse was aborted to protect the power switch. See section "Power supply requirements" on page 7 about how to resolve this problem.
Vcc low	The internally held up supply voltage fell below the minimum level that is required for the power switch to stay fully ON, and the pulse was aborted. This error indicates a circuit problem; please contact me at <a href="https://www.keenlab.de">https://www.keenlab.de</a> .
Spot R	The measured weld spot resistance was more than 100milliOhms, indicating a bad electrode contact.

## USING AUTOMATIC MODE

You can put the welder into automatic mode by stepping on the foot switch while the welder is not powered yet, and then connecting the power supply while keeping your foot down. When the system starts up, it detects that you have pressed the foot switch and enters automatic mode. It will stay in this mode until it is powered off. Alternatively, automatic mode can be activated through the menu – see section “Menu” on page 17 for details.

If you want to exclusively use the welder in automatic mode, you can also replace the foot switch with a piece of wire that shorts the two pulse trigger terminals on the *kWeld* circuit board.

Similar to manual mode, the system is armed whenever the following screen is shown (for details, please read the previous section). However, the system additionally beeps once every second to signal that it is in automatic mode.

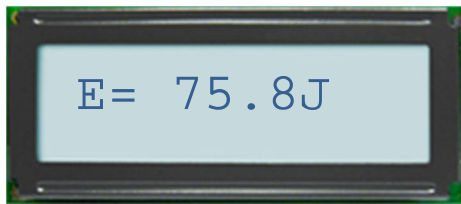

The welding procedure in automatic mode is as follows:

1. Firmly push one electrode down to the weld material.
2. When firmly pushing down the second electrode, you will hear a rising tone that warns you that a pulse will be triggered shortly.
3. If you keep both electrodes down for more than a given time (configurable through the menu - see page 17), the system executes a weld pulse. At this moment, it is important to keep pushing steadily, and not to wince. Keep pushing both electrodes down also after the pulse.  
*If you lift off the electrodes timely enough before pulse activation, the rising tone stops and you can repeat the entire procedure.*
4. After the pulse, listen to the sound from the welder, as it tells you if the welding process has succeeded or not:
  - a. one short beep signals success
  - b. a higher tone, followed by a lower tone, signals that something went wrong
5. Check the information that is displayed on the LCD (see details in the previous section).
6. When finished reading, lift both electrodes from your target. The results disappear from the LCD and the welder is instantly ready for another go.



## CALIBRATION

The *kWeld* system needs to measure the instantaneous power that it is delivering to the weld spot during a pulse, in order to be able to calculate the delivered energy amount. As it can only measure the output power at its bus bar terminals, it needs to subtract the power that is lost in the electrode cable system. To be able to do that, it needs to know its ohmic resistance. The calibration procedure described in the following serves this purpose.

A calibration needs to be executed in the following situations:

- You have just completed assembling the *kWeld* kit, and have powered it up the first time. In this situation, there is no calibration information available yet. Therefore the system does not allow welding, and offers calibration as the only option. To indicate this situation, it automatically selects the CAL command from the menu after startup. See section "Menu" on page 17 for details.
- You have changed something in the electrode system that could affect its ohmic resistance. This includes the situation in which you have just replaced worn out electrodes with fresh ones. Select the CAL command from the menu in this case.

The following assumes that you see this text on the LCD, which indicates that the CAL function has been selected from the menu:



The calibration process follows these steps:

1. Press and release the **dial knob** to enter calibration mode. The system now shows this screen:



2. Make sure that the electrodes are not in contact with each other.
3. Press and hold the **foot switch (or dial knob)**. After a quick measurement, the system shows this screen:

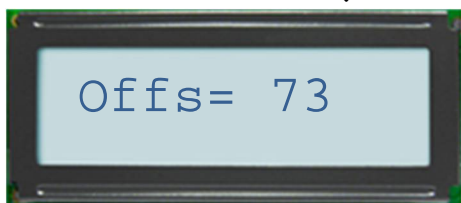

The shown value is the microprocessor's analog-to-digital converter conversion offset. Values between 50 and 100 are typical.

If something went wrong during the measurement, then some diagnostic information is displayed instead. As this should not happen during normal use, please write down this information and contact me at <https://www.keenlab.de>.

4. Release foot switch (or dial knob). The following screen is shown:



5. Firmly press both electrodes together.
6. While doing that, press and hold the foot switch (or dial knob) again. This triggers a special measurement pulse. After that has completed, the following screen is shown:

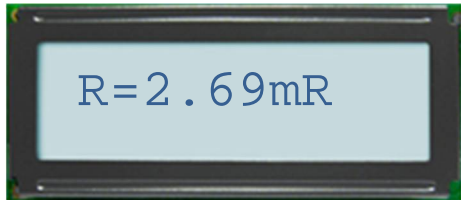

The displayed value is the measured ohmic resistance (milli-Ohms) of the entire electrode system. The internally stored calibration is now updated with the new results.

For the standard *kWeld* cable / electrode holder / electrode assembly, the value should range between 2.5 and 3.0 milli-Ohms. If you get a higher reading, then you may repeat the entire calibration procedure while pressing the electrodes together more firmly. If the readings stay consistently high, then you may check the electrode system for a loose connection.

If something went wrong during the measurement, then some diagnostic information is displayed instead.

If this continues to happen when repeating the procedure and you cannot find any loose connections in the electrode system, this may indicate a hardware problem. In this case, please write down this information and contact me at <https://www.keenlab.de>.

7. Separate the electrodes.
8. Release the foot switch (or dial knob) one more time. This completes the calibration.

If, at any time during the calibration process before step 6, you wish to abort it, then you can simply disconnect the power supply. This retains the existing calibration data (if any).

## MENU

The menu provides access to a number of built-in functions and configuration items. It can be entered by pressing and releasing the dial knob whenever the main screen is displayed, like for example:



The menu is automatically entered and the CAL menu item selected after startup, if the device has no stored calibration data (which is the case after delivery).

In the menu, the shown item can be changed by slowly turning the dial knob. Pressing and releasing the dial knob again selects the shown item.

The following commands are available:

Item	Default value	Description
CAL		Enters the cable resistance calibration mode (see section "Calibration" on page 15 for more details).
Mode		Toggles between manual and automatic trigger modes.
TrgDelay	0.5s	Configures the firing delay in automatic trigger mode. Dial in a new time between 0.1s and 5.0s, and press the dial knob once again to permanently store and activate the new setting.
DefaultE	10.0J	Configures the welding energy that is selected whenever the welder is powered up. Dial in a new energy level between 0.0J and 500.0J, and press the dial knob once again to permanently store and activate the new setting.
CableLen	1.0m	Configures the total length of <b>all</b> pieces of wire that carry the welding current. The standard <i>kWeld</i> electrode system accounts for 0.8m and the standard battery wire accounts for another 0.2m. Make sure to include the battery wires as well. Dial in a new length between 1.0m and 5.0m, and press the dial knob once again to permanently store the new setting. The software based overcurrent detection will be programmed with the new limit according to the calculations as discussed in section "Wiring requirements" on page 8.
LoBatt	0.0V	Configures the low battery voltage warning level. Dial in a new voltage between 0.0V and 40.0V, and press the dial knob once again to permanently store and activate the new setting.
Serial		Displays the unit's unique serial number.
BoardVer		Displays the unit's hardware revision number.
Exit		Leaves the menu without any further action.

## UPDATING THE FIRMWARE

The system firmware is upgradeable, allowing you to benefit from new features or improvements. In order to check if there is an available update, please visit the *kWeld* product page:

<https://www.keenlab.de/index.php/kweld/>

The update mechanism uses a simple serial connection. The shop has an affordable adapter kit:

<https://www.keenlab.de/index.php/product/kweld-firmware-update-tool/>

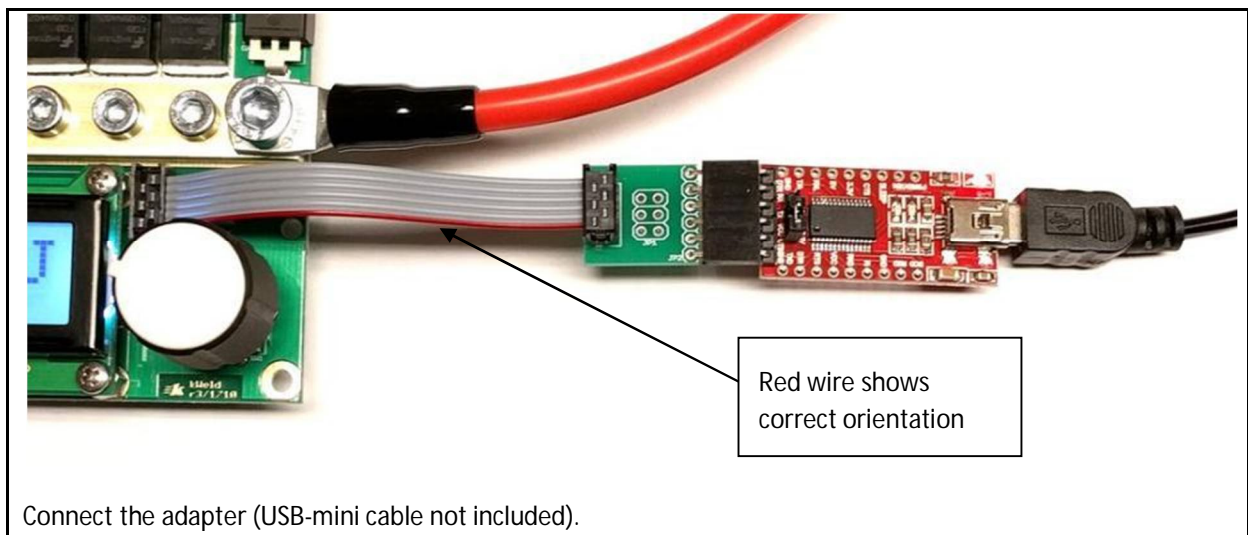
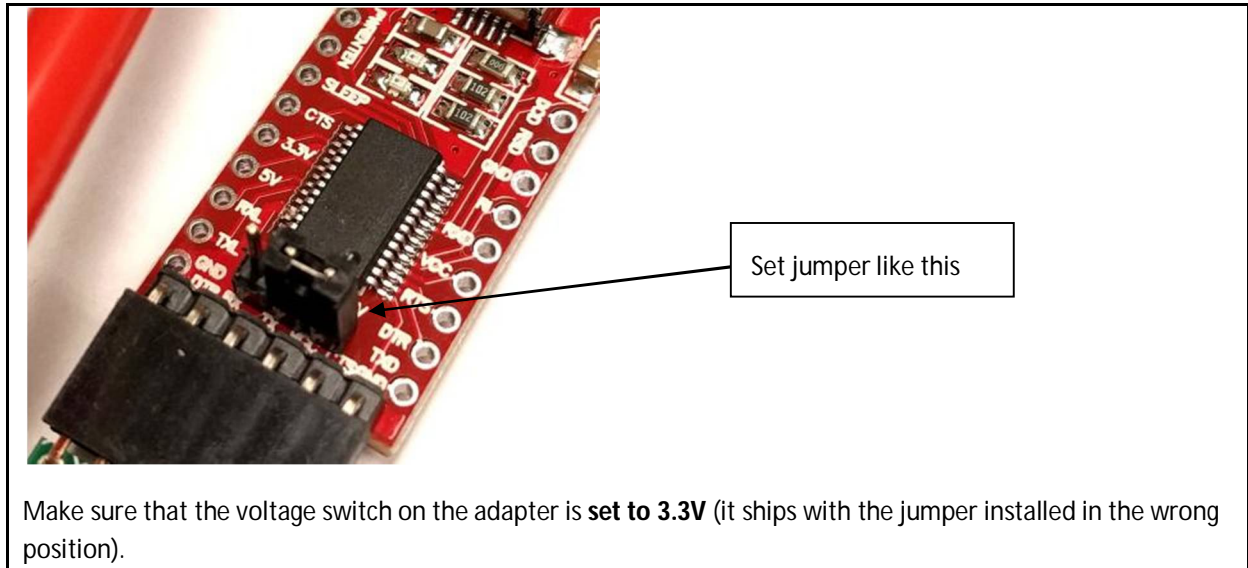

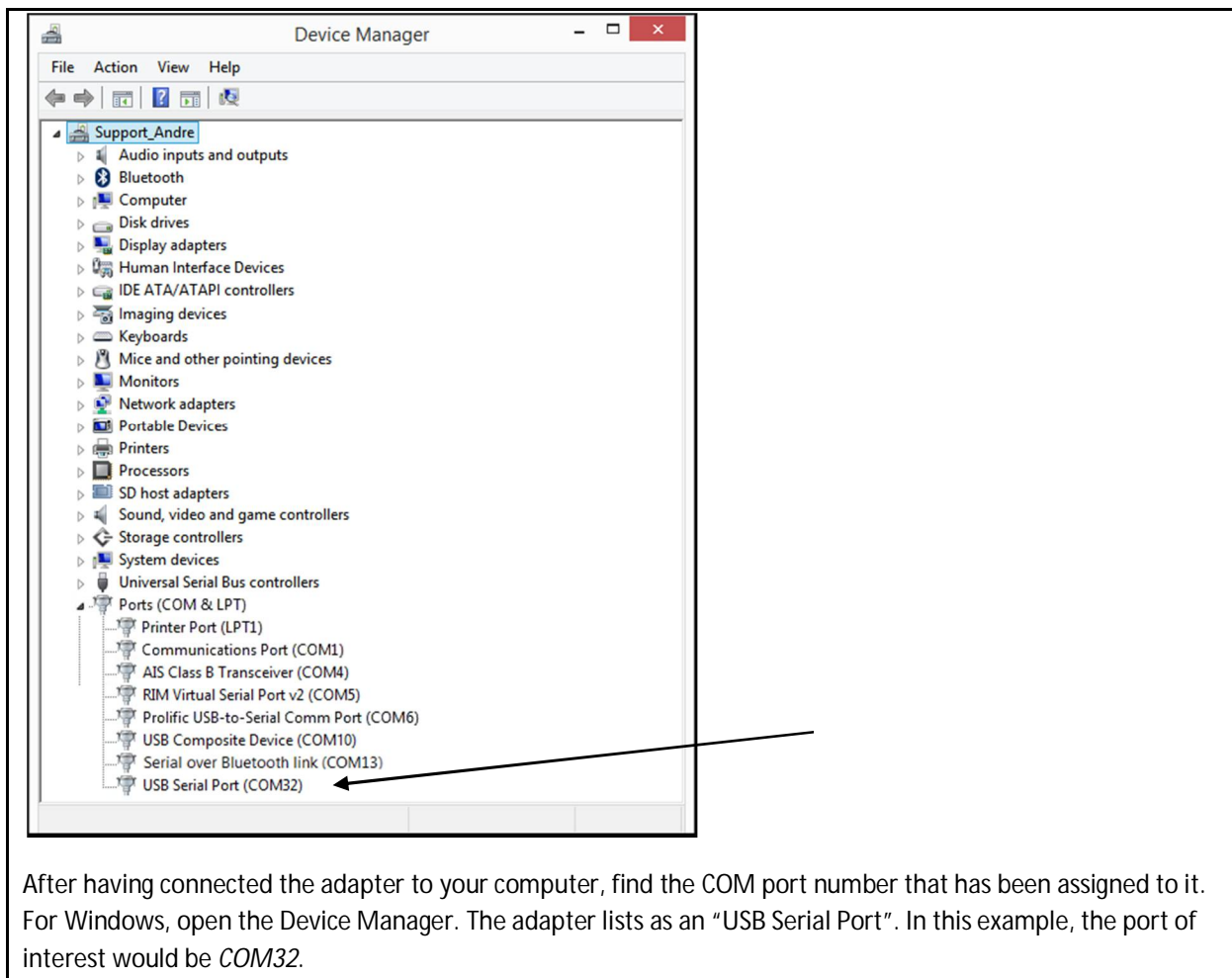
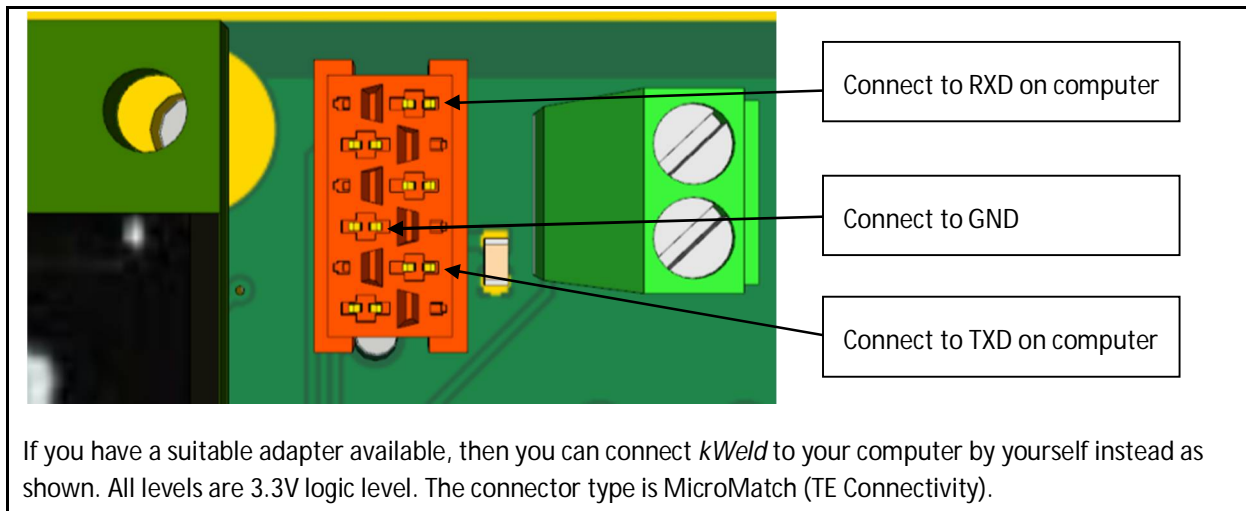

Download and install extraPutty from <http://www.extraputty.com/>.

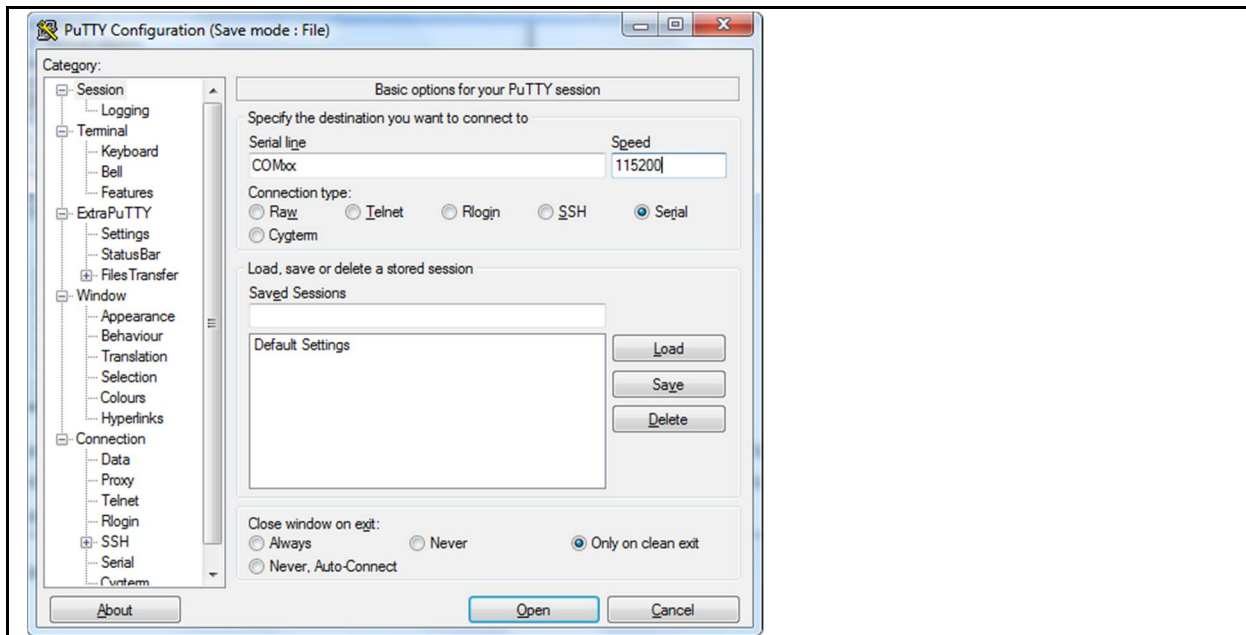

Start the application, and enter the above communication parameters. Replace the “xx” above with the COM port number that you have identified.

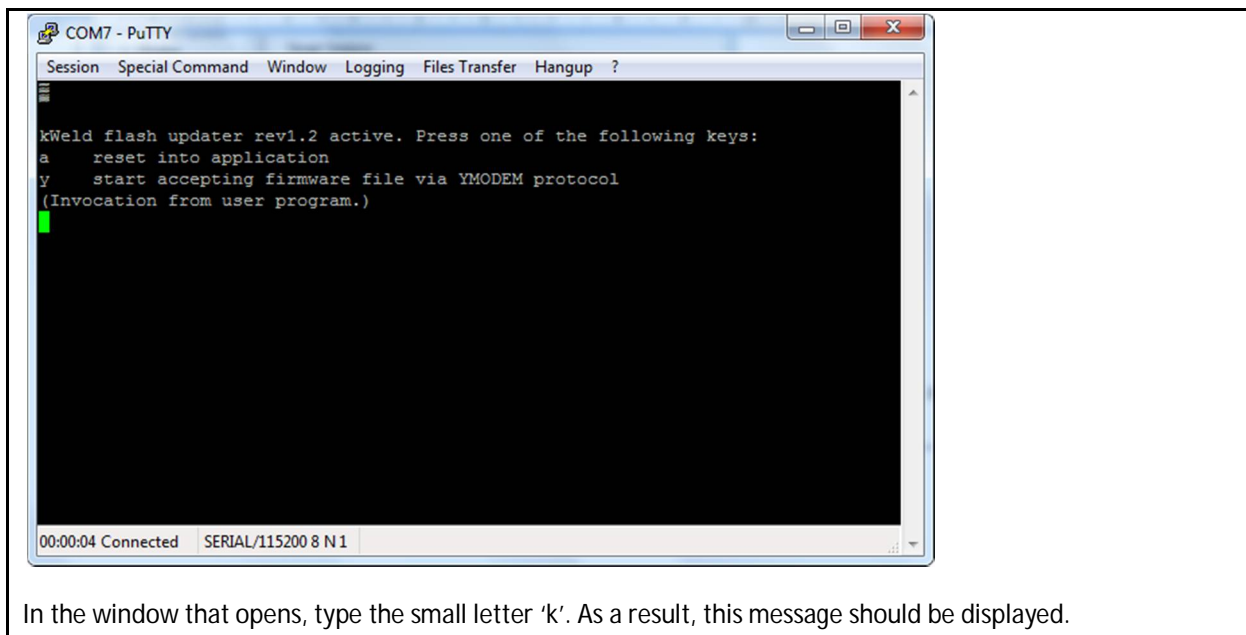

In the window that opens, type the small letter 'k'. As a result, this message should be displayed.





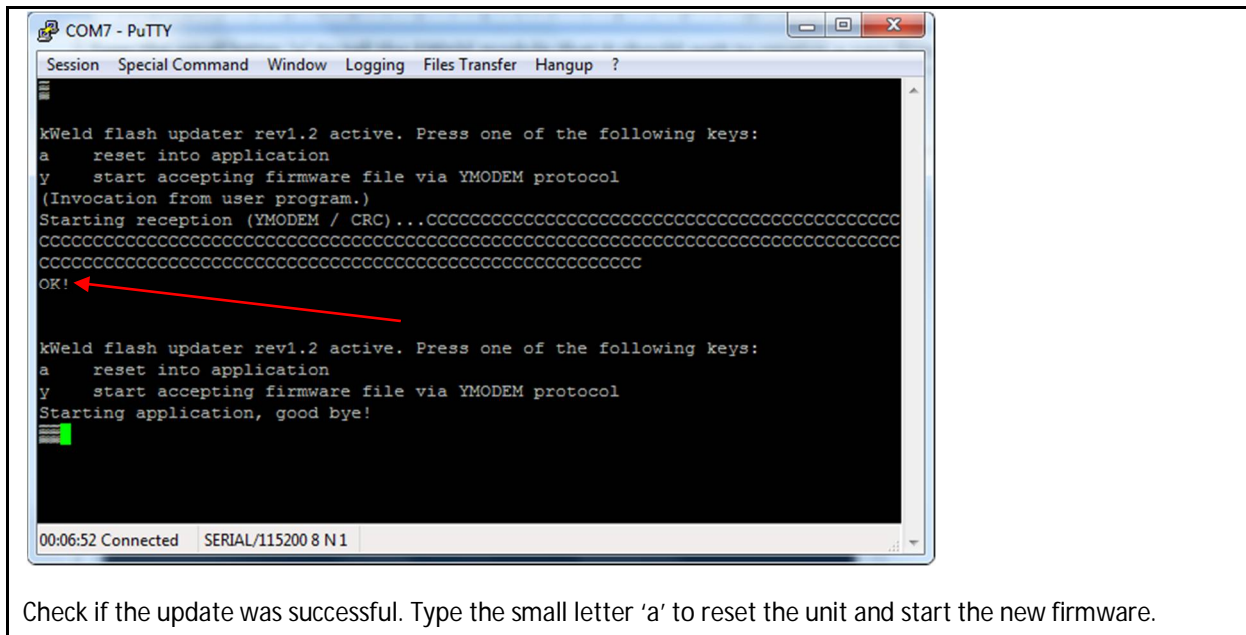

Check if the update was successful. Type the small letter 'a' to reset the unit and start the new firmware.

Finished!

Note: if you own a *kWeld* rev.2 and have upgraded it with an encoder by yourself, type the small letter 'v' followed by the digit '3' now. The unit should reset itself once again, and the encoder should work now. Typing 'v2' instead switches the firmware back to using a potentiometer.

Note: upgrading a stock *kWeld* rev.2 (with potentiometer) enables all new functionality, with some minor differences where unavoidable.

## REVISION HISTORY

0.1	2017-08-17	First published placeholder version
1.0	2017-08-27	Intermediate version with most important sections
2.0	2017-12-30	Updated to <i>kWeld</i> rev.3 <ul style="list-style-type: none"><li>- completed system overview</li><li>- completed firmware update process</li><li>- corrected ohmic system resistances with accurate values</li></ul>
3.0	2018-07-31	Updated to <i>kWeld</i> rev.3.2 <ul style="list-style-type: none"><li>- added temperature monitoring</li></ul>